

Integrated Ultrasonic Level Meter (Liquids, 5 to 20 m)



1. Overview

The AGRINOVO-ULM-100 is an integrated ultrasonic level meter for non-contact liquid level measurement in tanks, reservoirs, wells, and open channels. The transmitter, transducer, and LCD display are combined in a single field-mounted housing. Outputs include 4-20 mA (2-wire or 4-wire) and RS485 Modbus-RTU, with optional dual programmable relays for level alarms or pump control.

Range is selected at order time from the 5 m, 10 m, 15 m, and 20 m probe variants.

Key Features

- Non-contact measurement (no wetted electronics)
- Selectable range: 5 / 10 / 15 / 20 m
- 4-20 mA (2-wire or 4-wire) output
- RS485 Modbus-RTU communication
- Up to 2 programmable relays
- LCD display with menu keypad
- Display IP66, probe IP68
- 24 VDC standard, 220 VAC optional
- Automatic temperature compensation
- Anti-corrosion probe option (PVDF / PTFE)
- Multiple thread and flange connections
- Field-configurable from front panel

Applications

- Water tanks and irrigation reservoirs
 - Wastewater treatment basins, lift stations, weirs
 - Aquaculture ponds and recirculating systems
 - Slurry and effluent tanks
 - Open channel flow with weir geometry
 - Storage and dosing tanks for non-hazardous chemicals
-

2. Specifications

Measurement

Parameter	Specification
Measuring Range	5 m / 10 m / 15 m / 20 m (per probe variant)
Accuracy	0.5% to 1.0% of measured range
Resolution	3 mm or 0.1% of range
Blind Zone	0.3 m (5 m range), 0.4 m (10 m), 0.6 m (15 m), 0.8 m (20 m)
Measurement Modes	Level (default) or Distance
Application	Liquids (water, wastewater, slurry, non-corrosive media)
Temperature Compensation	Automatic, internal sensor

Electrical

Parameter	Specification
Power Supply	24 VDC standard, 220 VAC +15% / 50 Hz optional
Analog Output	4-20 mA, 2-wire (250 Ω max load) or 4-wire (510 Ω max load)
Digital Output	RS485 Modbus-RTU (or RS232 on request)
Relay Output	Optional 2 \times SPDT, AC 250 V / 8 A or DC 30 V / 5 A, programmable
Cable Entry	M20 \times 1.5

Mechanical and Environmental

Parameter	Specification
Display	LCD with keypad
Housing	Die-cast aluminium (single or dual chamber) or plastic
Protection Grade	Display IP66, Probe IP68
Probe Material	Standard polymer; PVDF or PTFE optional for corrosive media
Process Connection	Thread G1½, G2, M78×2, NPT 1½, NPT 2, or flange DN50 / DN65 / DN80 / DN100
Process Pressure	≤0.3 MPa (3 bar)
Process Temperature (probe)	-20°C to +80°C
Operating Temperature (display)	-20°C to +60°C

3. Measurement Modes

The meter supports two output modes, selectable from the front panel or via Modbus.

Level Mode (default)

4-20 mA output is proportional to liquid level (height of material above tank bottom).

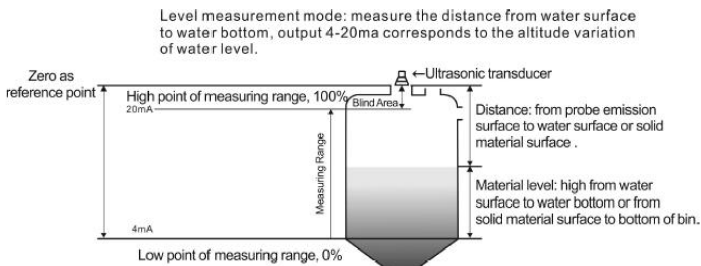

Distance Mode

4-20 mA output is proportional to distance from probe face to liquid surface (empty height).

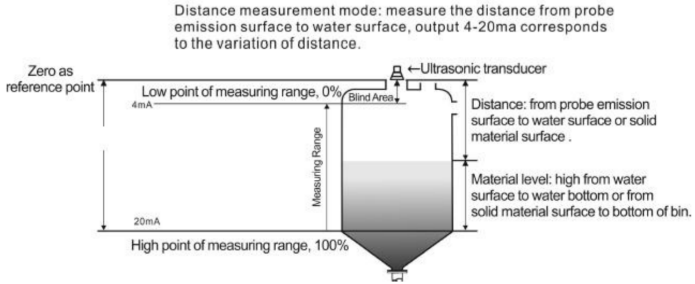

4. Dimensions

Integrated Threaded Variants

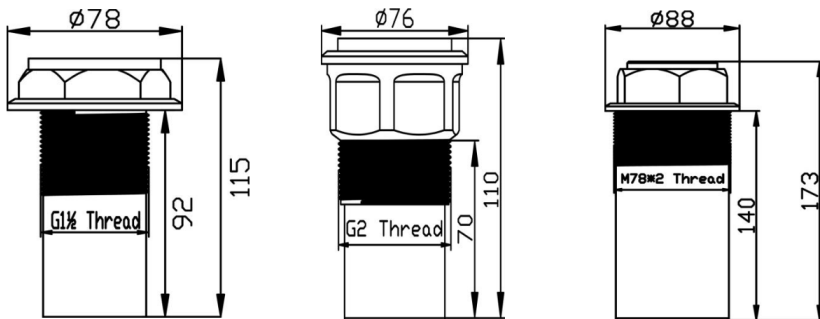

Range	Thread	Probe Diameter	Total Height
5 m	G1½	78 mm	115 mm
5 m / 10 m	G2	76 mm	110 mm
15 m / 20 m	M78×2	88 mm	173 mm

Flange-mounted and bracket-mounted variants are also available; contact Agrinovo for dimensions.

5. Installation

Position Selection

Install the meter perpendicular to the liquid surface. The space between the probe emitting face and the maximum liquid level must remain greater than the blind zone (see specifications table).

Avoid placement directly above fill streams, agitators, internal pipes, or weld seams. Any object within the beam path near the probe causes a strong false echo and corrupts the reading.

Flat-Top Tank with Connecting Pipe

When a short connecting pipe (nozzle) is used, the pipe length must not exceed 60 mm and the inner diameter must be at least 100 mm. The probe emitting face must protrude at least 3 cm below the underside of the flange.

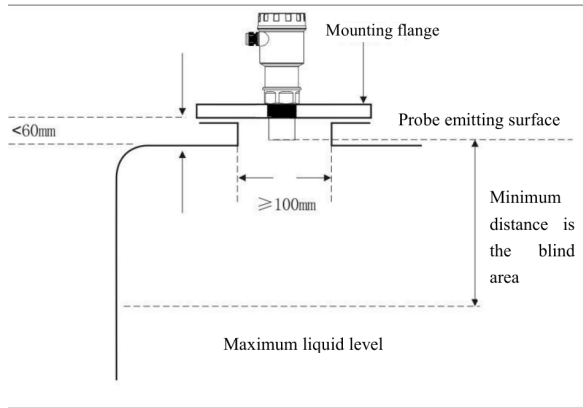

Direct Flange Mount

The cleanest installation is direct mounting on the flat tank top without any connecting pipe. The probe emitting face sits below the datum plane and the full sensor range is usable above the blind zone.

...izing or mounting range of certain joints. The probe emits in a
um plane.

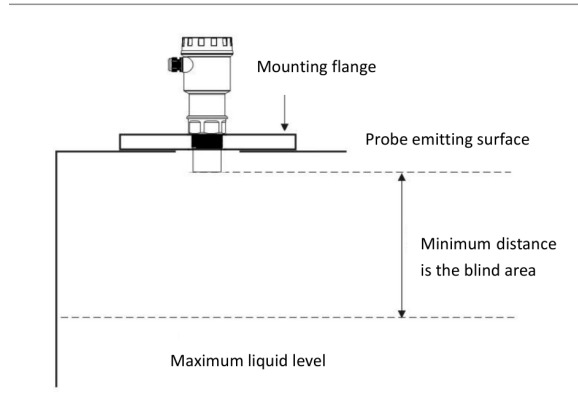

Open Container Mount

Use an installation bracket and maintain the minimum wall distance for the selected range. Because an open container has no focusing effect, the meter may be installed at the center.

Range	Min. Distance to Wall
5 m	0.5 m
10 m	1.0 m
15 m	1.5 m
20 m	2.5 m

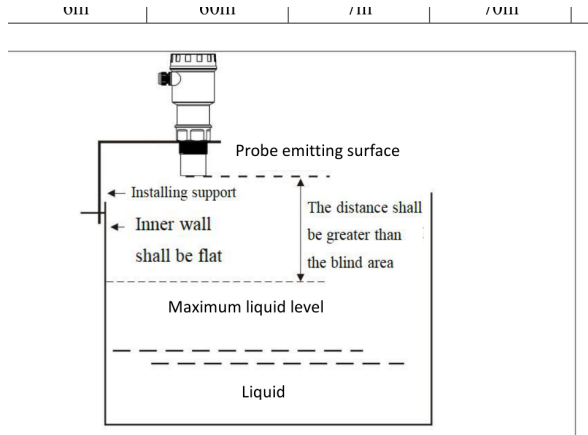

Notes

- Ultrasonic transmission requires a gaseous medium between the probe and the liquid surface. **Vacuum vessels are not suitable.**
- When installing by thread, the probe must not be in direct contact with the metal bracket. Use the supplied rubber rings to isolate it.
- Mount the probe at 1/2 or 2/3 of the tank-top radius on arch-roof tanks to avoid lens-focused false echoes.

6. Electrical Connections

Caution: AC power must only be connected to the AC terminals. Connecting AC to signal terminals will destroy the meter. The 485, 232, and 4-20 mA output terminals must not be short-circuited.

6.1 Four-Wire Terminal Layout

Diagram:

Wires:



6.2 Four-Wire Wiring Diagram

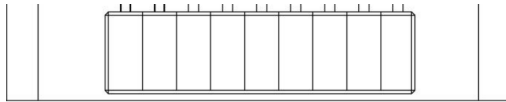

Wiring Diagram of Enhanced Integrated Type with Four-wire System

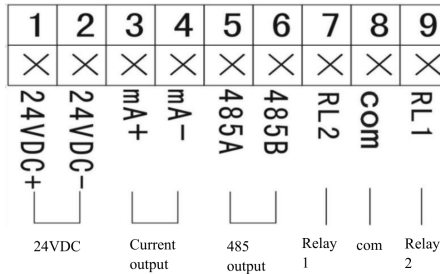

Terminal	Signal	Function
1, 2	24 VDC+ / 24 VDC-	Power supply
3, 4	mA+ / mA-	4-20 mA current output
5, 6	485A / 485B	RS485 Modbus communication
7, 8	RL2 / COM	Programmable relay 2
8, 9	COM / RL1	Programmable relay 1

6.3 Two-Wire Terminal Layout

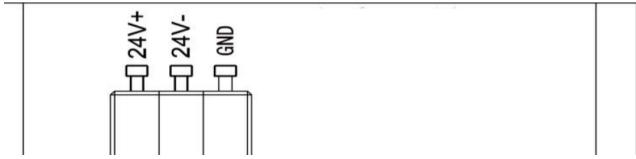

6.4 Two-Wire Wiring (4-20 mA loop powered)

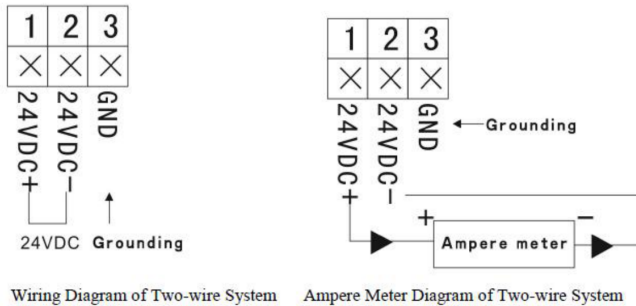

Wiring Diagram of Two-wire System

Ampere Meter Diagram of Two-wire System

Terminal	Signal	Function
1	24 VDC+	Loop supply +
2	24 VDC-	Loop supply / 4-20 mA return
3	GND	Earth ground

6.5 Grounding and Anti-Interference

- The meter must be grounded independently. Do not share grounding with frequency converters, motor drives, or panel boxes.

- Signal cables must not share a tray with power cables. Run signal cables in a separate metal conduit, or keep at least 1 m of separation.
- When the meter is powered alongside a VFD or motor, fit an isolation transformer on the supply side and a signal isolator on the analog output.

7. RS485 Modbus Communication

Communication Settings

Parameter	Value
Protocol	Modbus-RTU
Physical Layer	RS485, half-duplex
Frame	10 bits (1 start, 8 data, 1 stop, no parity)
Baud Rate	2400 / 4800 / 9600 (default) / 19200
Default Slave Address	0x01
Address Range	0x01 to 0xFE
Byte Order	Big-endian (higher byte first)
CRC	CRC16 Modbus (low byte first)

Function Codes

- **0x03** Read holding registers
- **0x06** Write single register
- **0x10** Write multiple registers

Register Map

Registers are partitioned into three areas. A single Modbus transaction must stay within one area.

Area	Range	Access
1	0x0000 to 0x0021	Read only
2	0x0022 to 0x005B	Read / write
3	0x005C to 0x006B	Read / write

Measurement registers (Area 1, function 0x03)

Address	Description	Format
0x0000	Instantaneous distance or level	UINT16, cm
0x0001	Instantaneous analog output	UINT16, raw
0x0002	Internal temperature	UINT16

The measurement register returns whichever quantity (distance or level) corresponds to the active measurement mode. The top bit of the high byte is the sign flag: 0 = positive, 1 = negative.

Range and alarm registers (Area 2, function 0x03 / 0x10)

Address	Description	Unit
0x0022 / 0x0023	Alarm 1 value / Alarm 1 return difference	as configured
0x0024 / 0x0025	Alarm 2 value / Alarm 2 return difference	as configured
0x0026 / 0x0027	Alarm 3 value / Alarm 3 return difference	as configured
0x0028 / 0x0029	Alarm 4 value / Alarm 4 return difference	as configured
0x002A	Reference zero point	as configured
0x002B	Range high point (20 mA)	as configured
0x002C	Range low point (4 mA)	as configured
0x002D	Current setpoint (wave-loss output)	mA × 1000
0x002E	Blind zone	as configured

Configuration registers (Area 3, function 0x03 / 0x10)

Address	High Byte	Low Byte
0x005C	Alarm 1 mode	Alarm 2 mode
0x005D	Alarm 3 mode	Alarm 4 mode
0x005E	Measurement mode	Unit option
0x005F	Algorithm option	Safe-level mode
0x0060	Probe type	Response speed
0x0061	Factory reset	System reset
0x0062	Baud rate	Working mode
0x006B	Sensor type character	Instrument address (read only)

Encoded Values

Field	Values
Measurement mode	0 = Distance, 1 = Level
Unit option	0 = mm, 1 = cm, 2 = m
Alarm mode	0 = Off, 1 = Low-level alarm, 2 = High-level alarm
Safe level (wave loss)	0x00 = Hold last, 0x55 = Output min, 0xAA = Output max, 0xA5 = Output set value
Response speed	0 = Slow, 1 = Medium, 2 = Fast
Baud rate	0 = 2400, 1 = 4800, 2 = 9600, 3 = 19200
Working mode	0 = Auto-report, 1 = Inquiry

Reading the Measured Value

Example: read measurement from address 0x01

Request: 01 03 00 00 00 01 84 0A

Response: 01 03 02 00 10 B9 88

Field	Bytes	Value
Raw register	0x00 0x10	16
Sign bit	0	Positive
Unit	cm	16 cm
Result		0.16 m

Example: negative reading (-0.16 m)

Response: 01 03 02 80 10 E8 06

The high byte 0x80 has its top bit set (sign = negative); the magnitude is 0x0010 = 16 cm.

Exception Codes

Code	Meaning
0x01	Illegal function code
0x02	Illegal data address
0x03	Illegal data value
0x04	CRC16 check error
0x05	Receive correctly
0x06	Receive error
0x07	Parameter error

8. Configuration Reference

Range Setup

Parameter	Description	Default
Bottom Distance	Reference zero point. Distance from probe face to tank bottom in level mode.	Maximum range
Range Low (4 mA)	Measurement value mapped to 4 mA output.	0
Range High (20 mA)	Measurement value mapped to 20 mA output.	Maximum range
Display Unit	m / cm / mm	m

Response and Damping

Setting	Effect
Slow	High noise immunity, slowest tracking
Medium	Balanced (factory default)
Fast	Lowest latency, lower noise immunity

Wave-Loss Behaviour

When echo is lost (turbulent surface, foam, beam blockage), the output follows the safe-level setting:

- **Hold** (default): retains the last valid value, current output unchanged
- **Min**: forces 4 mA
- **Max**: forces 20 mA
- **Set value**: forces a user-defined current between 3.6 mA and 22 mA

Relay Alarm Configuration (per relay)

Parameter	Range
Mode	Off / Low alarm / High alarm
Trigger value	meters
Return difference (hysteresis)	meters

A single relay can control a complete pump cycle. To drain a tank between 1 m (stop) and 5 m (start): High-level alarm mode, value = 5.00 m, return difference = 4.00 m.

Parameter Lock

Default unlock password is 25. The user may change the password at any time.

9. Application Notes

Signal Attenuation Budget

Real-world conditions reduce echo strength. Choose a meter range with margin equal to the sum of expected attenuations:

Condition	Attenuation
Light surface ripple	5 to 10 dB
Heavy surface fluctuation, agitator running	10 to 20 dB
Light dust	5 dB
Heavy dust	5 to 20 dB
Light vapour / mist	5 to 10 dB
Heavy vapour / steam	10 to 20 dB
Probe vs medium temperature difference $\leq 40^{\circ}\text{C}$	5 to 10 dB
Probe vs medium temperature difference $\leq 80^{\circ}\text{C}$	10 to 20 dB

For each 10 dB of attenuation, multiply the required range by 1×; for combined attenuation totalling 15 to 40 dB, choose a meter at least 3× the actual maximum measured distance.

Drainage Wells and Common Wells

Narrow wellheads require a measuring casing or connecting pipe. **Adding a pipe enlarges the blind zone by 50 to 100%.** For a 0.5 m native blind zone, expect 1.0 m once the casing is fitted.

Casing inner diameter must be ≥ 150 mm for measuring ranges up to 4 m. The inner wall must be smooth (PVC or PE works) and free of internal joints.

10. Ordering Configuration

The model number is built from the following fields. Contact Agrinovo to confirm a configuration before order.

Field	Options
Sensor type	Standard / Anti-corrosion
Housing	Die-cast aluminium single chamber (IP67), die-cast aluminium dual chamber (IP67), plastic (IP66), stainless steel (IP68)
Probe mounting and range	G1½ 5 m / G2 5 m or 10 m / M78×2 15 m or 20 m / NPT variants
Power supply	220 VAC / 24 VDC / custom
Output mode	4-20 mA 2-wire / 4-20 mA 4-wire / Modbus only / 4-20 mA + Modbus
Relay	None / 1 relay / 2 relays
Process connection	Thread (G1½, G2, M78×2, NPT 1½, NPT 2) or flange (DN50, DN65, DN80, DN100)

11. Fault Handling

Symptom	Likely Cause	Action
Meter does not power on	Power supply not connected	Inspect supply wiring
Display blank	Wiring loose between LCD and main board, or LCD damaged	Re-seat the wiring; return for service if persistent
Output frozen, trumpet icon static	Measured surface beyond range, heavy disturbance, dust, foam, or probe out of plumb	Select a larger range, allow medium to settle, re-aim probe perpendicular to surface, raise probe height, check for blockage in blind zone
Erratic readings	Strong nearby electromagnetic source (VFD, motor)	Verify grounding, add isolation transformer and signal isolator, separate signal and power cables